

Listing of Equivalent Items
available from **CHOICE ANALYTICAL**
for use on VARIAN ICP instrumentation

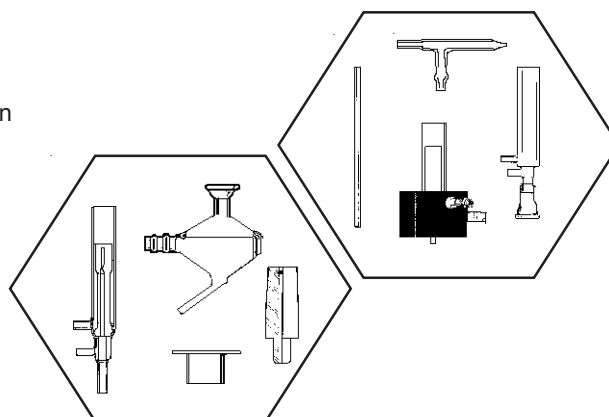

Quartz/Glass Items/Consumables Listing for Varian Liberty and Vista Series ICP and ICP-MS for illustrations of items see following page/s

In sequence of: VARIAN Part No.	Part No. Choice	Description
24-100675-00	800-45 800-46	Alumina Injector Tube, 1.8 mm ID Alumina Injector 2.5mm
20-100696-00B	800-05B 800-05W	Torch, ICP-ES, with ball joint Torch, ICP-ES, wear metals
20-100696-90	SVA-T01	Quartz Low Flow Torch, ICP-ES
20-100707-00	800-25 800-26 510-26T 510-26U 510-30	Torch Bonnet for SVA-T01 Spray Chamber, cyclonic, ¹² / ₅ socket top, 4mm drain Teflon Cyclonic Spray Chamber Ultem Cyclonic Spray Chamber Microcyclonic Spray Chamber (similar to Cinnabar)
20-100729-00	800-10	Inert Demountable Torch, ICP-ES, Body only, Radial
20-100730-00	800-41	Quartz Injector Tube, 1.8 mm ID
20-100764-00	800-08	Quartz Torch, ICP-ES, Extended for N ₂ determination
20-100775-00	800-42	Quartz Injector, 0.8mm
20-100783-00	800-06	Quartz Torch, ICP-MS
20-100793-00	800-11	Inert Demountable Torch, ICP-MS, Body only
20-100812-00	800-14	Torch, ICP Axial
20-100817-00	800-21	Spray chamber cyclonic, 8mm top, 4mm drain
20-100834-00	800-15	Torch, Demountable Axial, Body only
20-100904-00	800-12	Torch, Low Flow with 90° stem bend - axial
20-100948-00	800-13	Torch, Axial High Solids
20-101007-00	020-054-308	Torch, New Varian ICP-MS
20-101008-00	020-054-304	Sheath Gas Bypass, New Varian ICP-MS
20-101009-00	020-054-306	Sheath Gas Port, New Varian ICP-MS
20-101010-00	020-054-310	Spray Chamber, New Varian ICP-MS
30-808-0540	80016S	Axial Torch w/side arm
30-808-0875	8005BF	Radial Torch w/ball joint
99-100568-00	800-50	Kit, Torch Inert Demountable ICP-ES9 includes: Torch Body (800-10), Alumina Inj (800-45), Teflon Holder (800-48) 9-100570-00 (pack of 3) Order 3 x 800-41 above
99-100573-00	800-48	Injector Tube Holder, Teflon with O Ring
99-100704-00	800-17	Spray Chamber, Glass, Water Cooled
99-100717-00	800-51 800-75 800-76	Torch, Demountable complete Torch, High Solids, ICP-ES Torch, High Solids, ICP-MS
99-100847-00	800-49	Kit, Torch Demountable, Axial 1.8mm Injector, complete, includes Body (800-15), Alumina Inj. (800-45), Teflon Holder (800-48)

For **Nebulizers** both **Genuine J.E. Meinhard** as well as "**Clone**" type, and other types, see separate sheet.

ctd. page 2



CHOICE Analytical Pty Ltd

ABN 66 052 203 719

Supplies for Laboratory Instruments

Tel : + 61 2 9980 6240

Fax : + 61 2 9980 6344

E-mail : info@choiceanalytical.com.au

Web : www.choiceanalytical.com.au

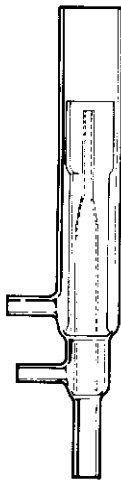

SVA-T01 Torch, ICP-ES
#800-06 Torch, ICP-MS

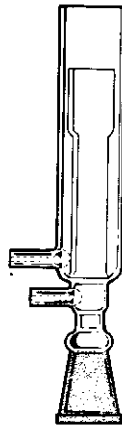

#800-10 Quartz Torch,
HF Demountable, ICP-ES
#800-11 Quartz Torch,
HF Demountable, ICP-MS

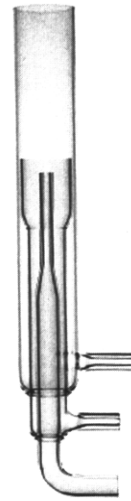

#800-12 Low Flow Torch, One
Piece, Axial, 90° Bend

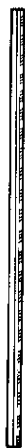

#800-45 Injector Tip
Alumina 1.8



#800-41 Injector Tip
Quartz 1.8

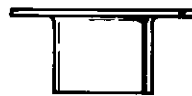

#800-25 Torch Bonnet

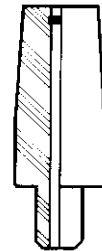

#800-48 Injector Tube
Holder Teflon

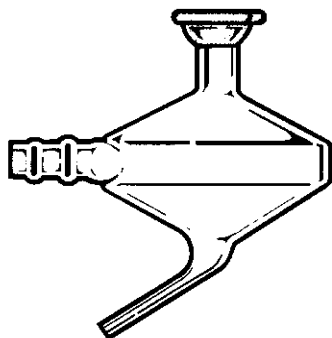

#800-15 Spray Chamber
cyclonic

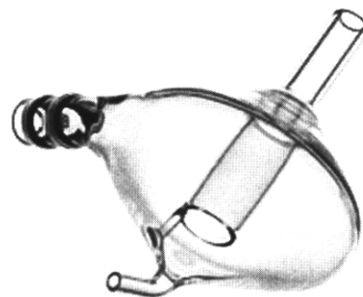

#800-21 Cyclonic Spray Chamber
8mm Top, 4mm Drain

Varian ICP Quartz Glass Items [w] Page2(2) 29/10/2007



CHOICE Analytical Pty Ltd

ABN 66 052 203 719

Supplies for Laboratory Instruments

Tel : + 61 2 9980 6240

Fax : + 61 2 9980 6344

E-mail : info@choiceanalytical.com.au

Web : www.choiceanalytical.com.au